

# BOSCH

洗衣机使用及安装说明书

Operating and Installation Instructions



WFD50810  
WFD50818

9000086867 (PD 85 12 10)

**BOSCH**

在使用本产品前，请您仔细阅读本使用说明书。

由于不遵守该使用及安装说明书中规定的注意事项，所引起的任何故障和损失均不在厂家的保修范围内，厂家亦不承担任何相关责任。请妥善保管好所有文件。如有疑问，请与当地的客户服务中心或经销商联系。

如果您需要英文说明书，请发送电子邮件，或拨打服务热线向客户服务部门免费索取。谢谢！

Please read this specification carefully before you use the product.

Any failure and losses caused by ignoring the above mentioned items and cautions mentioned in the operation and installation instruction are not covered by our warranty and any liability. Please keep all documents in a safety place for future reference. If you have any doubt, please contact our local service center of dealer.

If you need an English user manual, please send the E-mail to service department, or you can call up service hot line for free supply. Thanks!

生产厂家： 中德合资 博西威家用电器有限公司  
厂 址： 中国江苏省无锡市高新技术开发区旺庄路66号  
邮 编： 214028

# Table of Contents

**BOSCH**

---

<b>Operating Instructions</b>	Disposal Information . . . . .	2
	Environmental Protection/Conservation Issues . . . . .	2
	Safety Precautions and Warnings . . . . .	3
	Product Standard . . . . .	4
	Your New Washing Machine . . . . .	5
	First Wash Cycle . . . . .	9
	Preparing, Sorting and Loading the Laundry . . . . .	9
	Laundry Detergents and Additives . . . . .	13
	Washing . . . . .	14
	Programme Table . . . . .	17
	When the Programme has Ended. . . . .	18
	Cleaning and Care . . . . .	19
	Troubleshooting Minor Faults . . . . .	23

---

<b>Installation Instructions</b>	Installation, Connection and Transport . . . . .	26
----------------------------------	--	----

---

<b>Technical Data and Packing List Sheet</b>	Technical Data . . . . .	34
	Packing list sheet . . . . .	34

---

<b>Customer Service</b>	Warranty. . . . .	35
	Service Assurance . . . . .	36
	Warranty Card. . . . .	37

## Disposal Information

### The new machine's packaging

Dispose of packing materials in a responsible manner. Keep packing materials out of the reach of children. Packing materials are not toys. Reprocessing and re-using materials saves raw materials and reduces waste. All packing materials used are environment friendly and re-usable. Cardboard boxes consist of 80% to 100% recycled paper. Plastic wrappings are made from polythene(PE), the tapes are made from polypropylene(PP) and the CC-free packing is made from foamed polystyrene (PS). These materials are pure hydrocarbon compounds and can be recycled.

### Your old machine

Render the machine inoperable when it can no longer be used. Remove the plug from the socket and cut off the power cable. Destroy the catch on the porthole door. Prevent children at play from being locked in and risking death by suffocation. The old machine contains valuable materials which should be recycled. Please make your contribution to the environment by assisting with proper disposal or recycling.

## Environmental Protection

Through the economical use of energy, water and detergent, your appliance is kind to the environments as well as your household budget.

### You can increase the economy and environmental friendliness of your machine by washing maximum loads:

refer to page 17 programme table

#### ■ How to save energy:

For small amounts of laundry, the automatic control system reduces the consumption of both water and energy. Where possible, use the Cottons/coloureds 60° C programme with additional function "Super Clean" instead of the Cottons/coloureds 90°C Prewash programme. This 60° C programme achieves a cleaning result comparable to that of the 90° C programme using considerably less energy.

#### ■ How to save water, energy and detergent:

Avoid using the Pre-wash function when washing lightly normally soiled laundry.

#### ■ How to save energy and time:

For lightly soiled laundry, select the short programme appropriate to the type of textile.

#### ■ How to save detergent:

Add detergent according to the degree of soiling, amount of laundry and water hardness, and observe the detergent manufacturer's instructions.

## Precautions and Warnings

### Before using for the first time:

- Please read the enclosed documents carefully before using the washing machine for the first time. They contain important information on the installation, use and safety of the machine.
- The manufacturer does not accept liability if these instructions are not followed.
- Please contact an authorized technician to install the machine and instruct the using method.
- Please keep all documents in a safe place for future reference.
- Install the machine in accordance with the instructions (page 26-33). Remove the transit bolts and keep them in a safe place.
- The washing machine must be installed and operated in a room with the drain.
- When heating, the maximum current of the washing machine is 10A, so please make sure that the power supply system (voltage; current and the cable) is applicable to the load of the applied appliance.
- In order to ensure your safety, you must plug the cable into a socket which connected to earth. And please check your socket to make sure that it is connected with reliable earth correctly.
- If the washing machine is visibly damaged, do not connect it up. If you are in doubt, contact your customer service representative or dealer.
- This machine use thread connection water inlet hose, connect it to the water tap together with the machine according to the require of page 29. (carry out by an authorized technician)
- The surroundings condition for using the washing machine:
  - 1) Temperature range: 0~40 °C.
  - 2) Relative humidity is lower than 95% (at 25 °C) .

### When washing:

- Operate the machine with cold tap water only.
- Your washing machine is designed for domestic use only, i.e. for washing machine-washable textiles in a detergent solution.
- Never use flammable; explosible and/or poisonous solvents such as gasoline; alcohol etc. As the washing lotion. Please only use the lotions suitable for using in washing machine available in the market.

- Never wash the carpet in the washing machine.
- Kepp children and pets away from the washing machine.
- Exercise caution when pumping out hot detergent solution.

### When the programme has ended:

- When the programme has ended:  
The “Spin/End” indicator light flashes.  
Open the loading door after cutting the power of machine.
- After the program has ended, please cut the supply of power and water immediately.

### Taking care of your machine:

- Do not climb onto the washing machine.
- Do not lean against the door.
- Do not expose the machine in the place with causticity or explosibility gas.(e.g. dust, steam and gas, etc.)
- Do not install the washing machine in a bathroom or a room very wet.
- Please close the door gently. If the door could not be closed successfully, please check if the laundries overload or not balanced.

### Product Standard

This series loaders carry out national standards as following

- GB/T4288-2003
- GB4706.1-1998
- GB4706.24-2000
- GB4706.26-2000
- GB19606-2004
- GB4343.1-2003
- GB17625.1-2003

BOSCH

## Your New Washing Machine

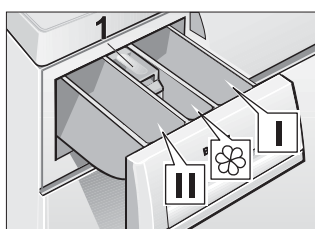

### Filling laundry detergent and/or additive dispensers.

Chamber I:  
Detergent for pre-wash, starch, or pre-soaking agent.

Chamber II:  
Detergent for main washing period, water softener, bleach and stain-removing salt.

Chamber III:  
Additives, e.g. fabric softener or former (Do not exceed Max )

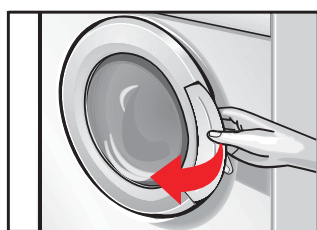

Open the loading door

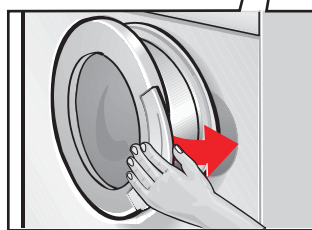

and close it

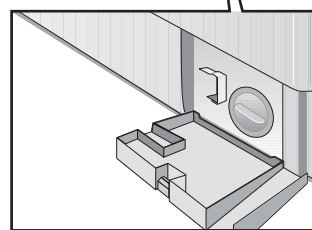

Drain washing solution if necessary.

\*The picture is only for WFD50810.

# Operating Instructions

BOSCH

## Control Panel

“开始/暂停”

### Start/Pause button

For starting/pausing the wash cycle (programme must have been selected).

### Programme Selector

For switching the machine on and off and for selecting the programme. Can be rotated in either direction. If rotate it during the washing, the programme will be stopped. The programme sequence is electronically controlled.

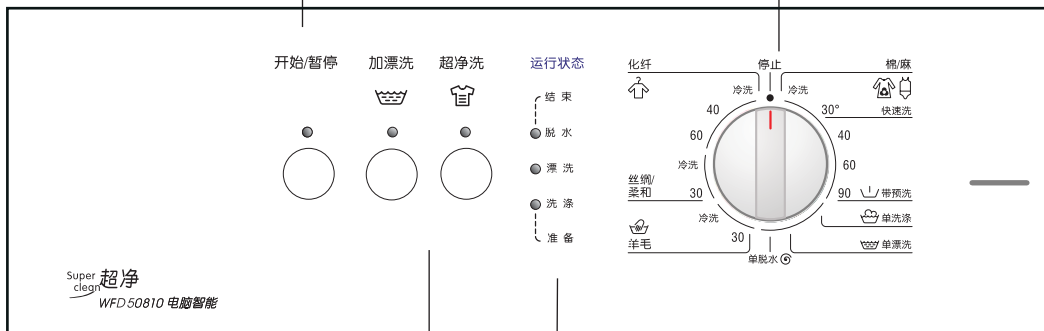

### Press buttons for additional functions

(Where required to supplement the programme)

加漂洗 **Extra Rinse**: Additional rinse cycle.  
超净洗 **Super Clean**: Prolong the washing time.  
Additional functions can be combined.

The indicator lights of the buttons come on, if the additional options are active.

Switch off additional option: press button again.

### Indicator lights

Indicate the status of the washing machine:

“准备/洗涤”

**Ready/Wash** Indicator light flashes, if the programme is selected; is on, the programme is running.

“漂洗”

**Rinse** indicator light is on, the rinsing cycle is running.

“脱水/结束”

**Spin/End** indicator light is on, the spinning cycle is running; flashes, if the selected programme is ended.



# Operating Instructions

BOSCH

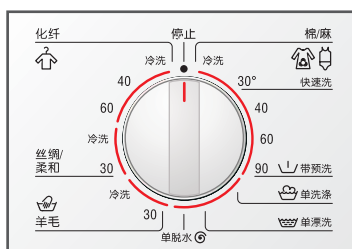

## ■ Basic program

Select the desired programme (refer also to “Programme table”).

### 90 °C Cottons/coloureds with Prewash

An energy-intensive programme for heat-resistant fabrics made from cotton or linen.

For the protection of the drainage pipe, the hot washing solution is mixed with approx. 5 liters of cold water before being drained.

Cold, 30 °C Quick, 40, 60 °C Cottons/coloureds  
For hard-wearing fabrics.

Cold, 40, 60 °C Easy-care  
For easy-care fabrics made from cotton, synthetics or blend-ed fibres.

Cold, 30 °C Delicates  
For sensitive, easy-care fabrics made from cotton, synthetics or blended fibres, and net curtain. No spinning between rinsing cycles.

Cold, 30 °C Wool   
For hand or machine-washable fabrics made from wool or wool blend.

## ■ Additional function

### Single wash 单洗涤

Single wash cycle without subsequent drain and spin cycle.

### Rinse 单漂洗

Rinse cycle with subsequent spin cycle for rinsing hand-washed items or for starching.

### Spin 单脱水

Spin cycle for spinning hand-washed items. Washing water or rinsing water is drained before the spin cycle.

## ■ Spin speed button

For your clothes, there are different spin speeds in different washing programme of BOSCH washing machines.

Maximum spin speed (rpm) Programme model	Cottons	I Easy-care	Delicates	Wool	Single wash <sup>*</sup>	Rinse	Spin
	WFD50810	800	800	600	800	800	800
WFD50818	800	800	600	800	800	800	800

\* Single wash cycle without subsequent spin cycle, if the spin cycle is desired after this wash cycle, please select the additional function **Extra Rinse**.

Maximum noise value during spinning: 68 dB(A).



## ■ Additional function

(You can select an additional function if necessary)

### Extra Rinse 加漂洗

An additional rinsing cycle performed; the washing duration will be prolonged 10 minutes.

### Super Clean 超净洗

For very dirty clothes, the washing duration will be prolonged 20 to 60 minutes after pressing this button, and this is decided by the programme that you selected.

Observe the maximum load for each type of fabric; Remove the laundry immediately after the spin cycle.

## ■ Program duration

 While the programme is running, the programme duration may be extended or reduced for the following reasons.

**Reductions in time** occur because of :

- small loads,
- reduced heating times, e.g. If the water is very hot.

**Increases in time** occur because of:

- additional rinse cycle if excessive foam is in the laundry,
- multiple spinning if the laundry is distributed poorly in the drum,
- increased heating times, e.g. When the water is too cold,
- water pressure too low,
- selection of an additional option, e.g. "Super Clean" function after the programme has started.
- Very absorbent washing extends the heating duration.

# Operating Instructions

BOSCH

## First Wash Cycle

The installation of the washing machine is finished. (See page 26-33)

Each machine has been tested in the factory. A little bit of water can be left in the drum during the test. Please carry out the first wash cycle without laundry to remove any water left over from the factory tests.



- Do not load any laundry.
- Turn the tap ON.
- Pull the detergent drawer out as far as it will go.
- Input about 1 liter of water in chamber II.
- Pour half a measuring cup of detergent into chamber II.
- Do not use a special detergent for delicates or wollens as these will create too much foam.
- Close the detergent drawer and the washing machine door.
- Turn the programme selector to “Cottons/coloureds 90° C Prewash”, “Ready/Wash” indicator light flashes.
- Press the “Start/Pause” button. The programme starts.
- The “Spin/End” indicator light flashes if the selected programme is ended.
- Turn the programme selector to O off 停止 .

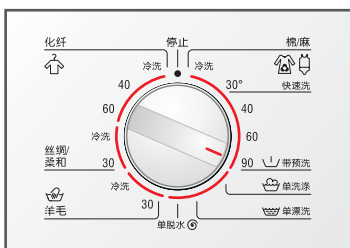

## Preparing/sorting and loading the laundry



### Preparing the laundry

- Remove any loose items or metal objects, such as safety pins, paper clips, etc. from the laundry.
- Brush sand, coins, etc. out of pocket and cuffs.
- Close zips and button up cushion covers, duvet covers, etc.
- Remove curtain runners, or secure them in a net bag.
- Particularly delicate items, such as tights or lace curtains, or smaller items, such as tiny socks or handkerchiefs, should only be washed in a net bag or pillow case.
- Some items are best turned inside out. These included knitwear, trousers, T-shirts and sweatshirts.

**BOSCH**

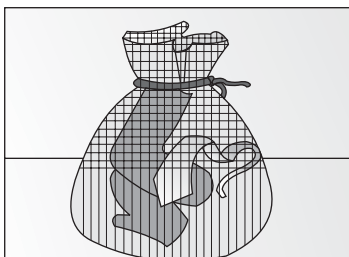

- Make sure that the wire-cup bras are machine washable.

Make sure that wire-cup bras in a pillow case which can be securely closed with a zip or buttons. If the wire works itself out of the cup it may fall through the holes of the drum and cause extensive damage.

## Sorting the laundry

- According to colour and degree of dirt

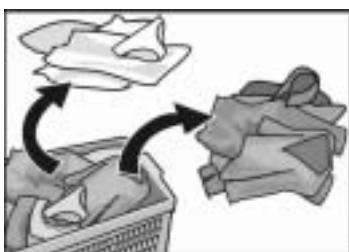

### Caution

Items of clothing can become discoloured. Never wash new multi-coloured items together with other items.

White items may become grey. Always wash white and coloured items separately.

## Degree of dirt

### Slight dirt

No recognizable dirt or staining. Laundry may have some body odour.

- Light summer clothing and sportswear that has only been worn for a few hours.
- T-shirts, shirts and blouses that have been used for one day.
- Bed linen and guest towels that have been used for one day.

### Normal dirt

Visible dirt and/or some light staining recognizable.

- T-shirts, shirts and blouses that are very sweaty or have been worn several times.
- Underwear that has been worn for one day.
- Tea towels, hand towels and bed linen that have been used for up to one week.
- Net curtains (without nicotine staining) that have not been washed for up to 1/2 year.



### Intensive dirt

Dirt and/or staining recognizable.

- Kitchen hand towels that have been used for up to one week.
- Fabric napkins.
- Children's outer clothing or football shirts and shorts with grass and soil stains.
- working clothes such as overalls or baker's and butcher's coats.

### Typical stains

- Skin fat, cooking oils/fat, sauces, mineral oil, wax(containing fat/oil)
- Tea, coffee, red wine, fruit, vegetables(bleachable).
- Blood, egg, milk, starch(containing protein/carbohydrate).
- Soot, soil, sand(pigments), red sand on tennis clothes.

### Removing stains

Wherever possible, remove/pretreat stains whilst they are still fresh. First, dab soapy water onto the stain. Do not rub. Subsequently wash the items of clothing using the appropriate programme. Several washing cycles may sometimes be required in order to remove stubborn/dried in stains.

### ■ Sorting laundry according to their care label specifications

Only wash laundry that is labelled with the following care symbols:

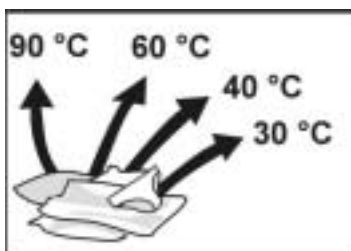

90°C Cottons + lines



60°C, 40°C, 30°C Cottons + lines



60°C, 40°C, 30°C Easy-care



40°C, 30°C Delicates



40°C, 30°C Wollens (hand and machine-washable)

Laundry that is labelled with the following care symbol must not be washed in the washing machine.

= do not wash

## Loading the laundry

### ⚠ Risk of explosion

Items of clothing that have been pretreated with solvent-based cleaning agents, e.g. Stain remover and dry cleaning spirit, represent an explosion hazard once loaded into the washing machine.

Therefore, these items must be rinsed thoroughly by hand.

### Risk of explosion

Loose debris in the washing machine drum can damage the laundry. Before loading the laundry, check that there is no debris in the drum.



- Open the loading door.



- Unfold the sorted items of clothing and place them loosely into the drum. Mix up large and small items. Items of varying size will distribute better during the spin cycle..
- Do not exceed the maximum load: Overloading will cause poor wash results and encourage creasing.
- When washing a small amount of laundry, the washing machine automatically reduces the amount of the water and energy used.



- Close the loading door.  
Take care not to trap any items of clothing between the loading door and rubber seal.



## Laundry Detergents and Additives

### **⚠ Risk of explosion**

- Do not use solvent-based cleaning agents in fully automatic washing machines. **Explosion hazard.**
- Keep detergents and additives out of the reach of children.

You can use any standard powder or liquid detergent which is suitable for automatic washing machines. Do not use any detergent boosters containing solvents or dirt and stain-removing spraying near the machine, as these could damage the machine. Do not use non-automatic detergent as these produce too much foam.

### **Amount of detergent**

The best washing results will only be achieved if you add the correct amount of detergent. Observe the instructions for use shown on the detergent packaging.

When using liquid detergents, you can use any measuring aids provided with the detergent, such as dosage balls or bags.

Please put the liquid detergents into correct chamber.

The amount of detergent depends on:

- water hardness
- degree of soiling
- size of load
- amount of detergent to be added according to its manufacturer.

Dispensing the correct amount of detergent relieves the strain on the environment and ensures optimum washing results.

Frequent use of insufficient detergent will eventually become noticeable as followings:

- washing appears grey or not properly clean
- grey-brown stains (grease marks) form on the washing

Too much detergent results in:

- unnecessarily high environmental pollution
- due to the generation of too much foam, the washing is hardly agitated which leads to poor washing results.

The amount of detergent indicated on its packaging refers to a full machine load.

For small loads or less soiling, reduce the amount of detergent.

# Operating Instructions

BOSCH

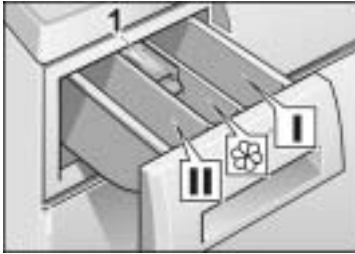

## Filling laundry detergent and/or additive dispensers

- Do not fill beyond the “Max” mark, otherwise will be flushed into the machine together with the detergent at the start of the program.

- If the liquid additive is thick, mix with a little water before dispensing (prevents clogging of the overflow).

- Pull out the detergent dispenser up to the end stop.
- Add the detergent and/or additive.
- Close the detergent dispenser.

## Washing



1. Turn on the water tap.

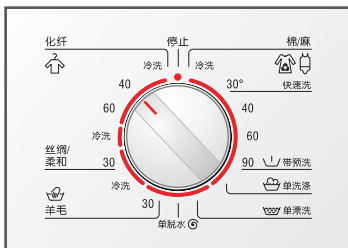

2. Turn the programme selector to the desired programme (refer to “ Programme table ” page17 ).

The “ Ready/Wash ” indicator light flashes.



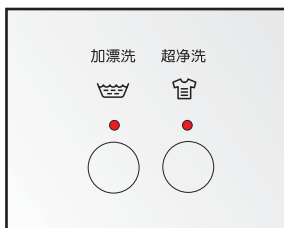

**BOSCH**

3. If required, press the button(s) for additional option(s). The indicator light of the selected button is on.

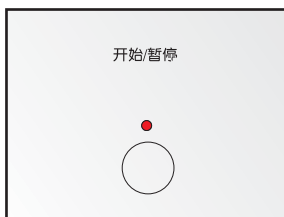

4. Press the "Start/Pause" button. The programme starts. "Ready/Wash" indicator light is on.

Maximum noise value during washing: 54.9 dB(A).

### Changing the programme

If you have accidentally selected the wrong programme:

- Turn the programme selector to "○ off".
- Turn the programme selector to the desired programme. The "Ready/Wash" indicator light flashes.
- If required, changing the other settings, see page 15.
- Press the "Start/Pause" button. The "Ready/Wash" indicator light comes on and the new programme starts.

### Cancelling the programme

If you wish to prematurely end a programme:

- Turn the programme selector to "○ off".
- Turn the programme selector to "Spin". The "Ready/Wash" indicator light flashes.
- Press the "Start/Pause" button. The "Ready/Wash" indicator light stop flashing, the "Spin/End" indicator light comes on.

### A pause in active programme

If you want to add/remove the laundry during active programme and the set programme sequence will not be changed.

- Press the “Start/Pause” button during the working cycle, “Start/Pause” indicator flashes, the programme is pause.
  1. “Reday/Wash” indicator is on: cannot add or remove laundry, for your safety, in some period of time the loading door cannot be opened.
  2. “Reday/Wash” indicator flashes: the laundry can be added/removed. Wait about 2 minutes, “Ready/Wash” indicator light goes off, open the door, add/remove the laundry, close the loading door.
- If required, press the “Start/Pause” button again, the programme restarts, “Start/Pause” indicator light is on and the washing machine continue the interrupted programme.

# Operating Instructions

## BOSCH Programme Table

Always follow the manufacturer's care label instructions		Laundry up to(kg)	Detergent and fabric softener			Additional function		Programme duration in minutes *** (approx. time)
			Chamber I	Chamber II	Chamber 	Super Clean	Extra rinse **	
Programme								
<b>Cottons/coloureds</b>	Cold	5.2		●	○	○	○	70(110)*
	30°C Quick	5.2		●	○	○	○	39(59)*
	40°C	5.2		●	○	○	○	80(120)*
	60°C	5.2		●	○	○	○	90(138)*
	90°C Prewash	5.2	●	●	○	○	○	140(180)*
<b>Easy-Care</b>	Cold	2.6		●	○	○	○	50(70)*
	40° C	2.6		●	○	○	○	60(80)*
	60° C	2.6		●	○	○	○	70(90)*
<b>Delicate</b>	Cold	2.0		●	○	○	○	50(70)*
	30 °C	2.0		●	○	○	○	55(75)*
<b>Wool</b>	Cold	2.0		●	○	○	○	35(55)*
	30 °C	2.0		●	○	○	○	40(60)*
	Single wash	3.5			○	○	○	20(40)*
	Rinse						○	14
	Spin							8

- \* Time shown in "( )" is the programme duration after selecting "Super Clean".
  - \*\* After selecting "Extra rinsing", the program duration will prolong 10 minutes.
  - \*\*\* The following duration is required when you operate the machine according to the instruction of user manual (page 14 to 17).
- = obligatory  
○ = optional

# Operating Instructions

BOSCH

## When the Programme has Ended

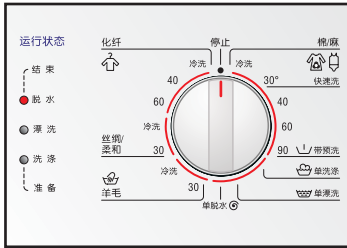

“Spin/End” indicator light flashes.

- Turn the programme selector to “○ Off”.
- If required:
  - Select an additional programme (Spin or Rinse).
  - Press the “Start/Pause” button.
  - At the end of the programme option, turn the programme selector to Off.

## Unloading the laundry



- Turn off the water tap.
- Open the loading door.  
If the loading door can not be opened:  
Wait for 2 minutes ( the safety function is active ).



- Unload the laundry.  
**Caution:**  
**Remove any debris (e.g. Coins, paper clips ) from the drum and rubber seal---risk of rust formation!**
- Leave the loading door open to allow the inside the washing machine to dry out.



## Cleaning and Care

### Risk of electric shock!

Always disconnect the appliance from the mains before cleaning.

Never clean the washing machine with a jet of water.

### Risk of explosion!

Never use solvents to clean the appliance.

## Cleaning the appliance housing and control panel

As required:

- Use hot soapy water or a mild, non-abrasive cleaning agent.
- Rub dry with a soft towel.

## Cleaning the drum

In the event that rust spots have formed due to leftover debris (e.g. Coins, paper clips, needles, nails):

- Use a chlorine-free cleaning agent. Follow the manufacturer's instructions. Never use steel wool.

## Clean the detergent dispenser

In the event that residual detergents or additives have accumulated.

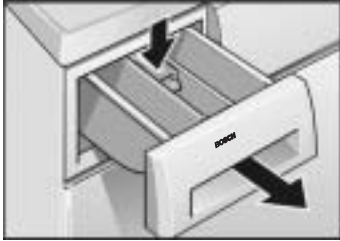

- Pull out the detergent dispenser up to the end stop.
- Press down the hollow on the insert and remove the detergent dispenser completely.

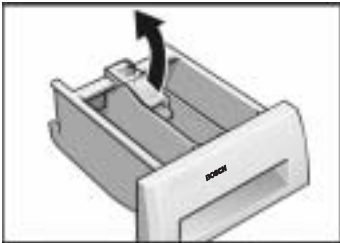

- Pull up the insert.
- Rinse the detergent dispenser under hot running water.

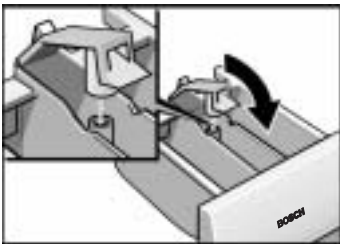

- Push down the insert until it clicks into place.
- Insert the detergent dispenser.

## Clean the drain pump

This is necessary if the washing solution can not be completely drained. The pump is blocked by either loose debris or fluff which accumulates if fluff-giving fabrics are washed at high temperature.

## Draining the washing solution

The water in the drum should be drained first before cleaning the drain pump. Have a suitable container ready.

### Risk of Scalding

Allow the hot washing solution to cool.

- Turn the programme selector to "Off".
- Fold down the cover panel.

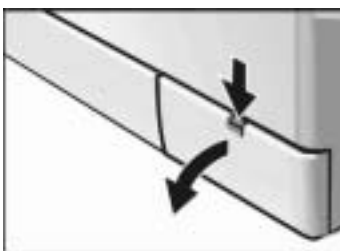

(WFD50810)



**BOSCH**

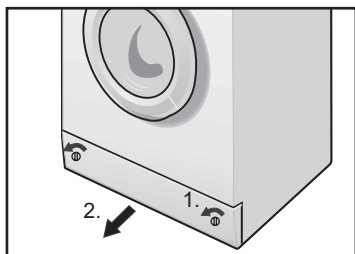

(WFD50818)

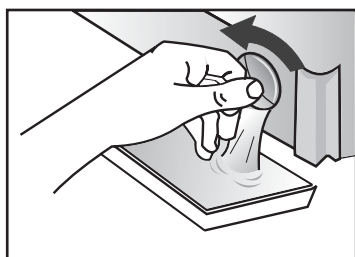

- Carefully remove the pump cap. But do not fully remove it and allow a little more residual water flow into the suitable container.

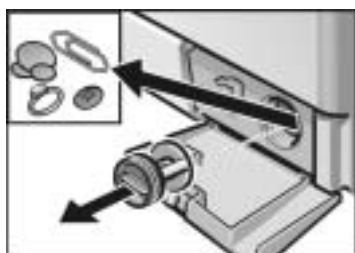

- Remove the pump cap.
- Remove any loose debris/fluff from inside the pump and clean the pump. The pump impeller must be able to rotate. Clean any residual suds or fluff from the thread of the pump cap and pump housing.

(WFD50810)

- Attach and tighten the pump cap.
- Attach and close the cover plate.

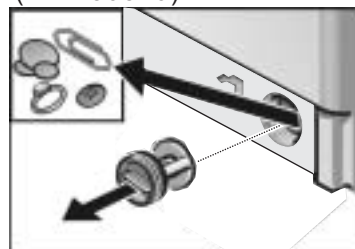

(WFD50818)

To avoid unused detergent from flowing into the drain during the next wash cycle:

- Pour 1 litre of water into chamber II
- Select the "Spin" programme.

## Cleaning water inlet strainers

This necessary if very little or no water flows into the washing machine.

First release the water pressure in the supply hose:

- Turn of the water tap.
- Turn the programme selector to any programme. (Except "Spin")
- Press the " Start/Pause" button, and allow the programme to run for approx.40 seconds.

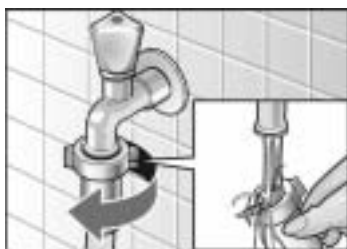

## Cleaning the strainer at the water tap

- Disconnect the hose from the water tap.
- Rinse the strainer under flowing water.
- Reconnect the hose.

## Cleaning the strainer on the washing machine



- Disconnect the hose from the back of the washing machine.
- Pull out the strainer and rinse under running water.
- Insert the strainer and reconnect the hose.
- Turn on the water tap and check whether water is still discharged. If water is still discharged, check that the strainer is attached properly.
- Turn off the water tap.



## Descaling the washing machine

### Caution:

Descaling agents contain acids which can attack parts of the washing machine and discolour the laundry. Provided that you use the correct amount of detergent, it is not necessary to descale the washing machine. If, however, descaling the appliance becomes necessary, please follow the instructions provided by the descaling agent manufacturer.

### Frost protection

If the machine is located in a room which is exposed to freezing temperatures, any residual water in both the pump and the water inlet hose must be drained immediately every time the machine is used.

#### Draining the pump:

See "Cleaning the pump" on page 20.

#### Draining the water inlet hose:

1. Turn the tap OFF.
2. Unscrew the hose from the tap and hold the end of the hose over a container.
3. Switch ON any of the washing programmes for approximately 40 seconds. Water left inside the inlet hose will be drained out.
4. Screw the hose back onto the tap.





## Trouble Shooting Minor Faults

### Risk of electric shock

Repairs must only be carried out by our Customer Service or an authorized technician.

If repairs are needed, and assuming that you cannot eliminate the fault yourself with the aid of the following table:

- Turn the programme selector to “Off” .
- Disconnect the washing machine from the mains.
- Turn off the water tap.
- Call Customer Service.

Fault	Possible cause	Action
The loading door cannot be opened.	There is water in drum.	Select “ Spin ”.
	Safety function is active.	Wait for 2 minutes.
Detergent residue in the detergent dispenser.	Detergent was damp or lumpy.	Clean and dry the detergent dispenser(refer to Page 21)
		Use the dispensing aid for liquid detergent.
The gasket is crimped.	This may appear after installing the transport bolts.	Remove the transport bolts, operate the machine for a period of time, the gasket will return to the original shape.
The belt gets off the pulley.	Too much laundry is in the drum or the laundry is put in badly, and close the window with excessive force.	Put in the laundry well and according to the maximum load specification.
Control lights do not come on.	A fuse has triggered.	Switch on/replace the fuse. Call Customer Service if this fault is repeated.
	Power failure.	An interrupted program will be resumed when power returns. If you wish to unload the laundry, proceed as in Cleaning the drain pump , Page 20.
	Plug is loose or not inserted.	Insert the plug.
Ready/Wash and Rinse control lights flash.	Loading door not closed.	Check whether laundry is trapped in door.
		Close the loading door(a click should be heard).
The programme does not start.	Loading door not closed.	Same solution as above.
	“Start/Pause” button does not pressed.	Press the “Start/Pause” button.
Water does not enter the machine or detergent is not wash away. Ready/Wash and Spin/End control lights flash.	Water tap not turned on.	Turn on water tap.
	Strainer in supply hose clogged.	Clean the strainer (refer to Page 21)

# Operating Instructions

**BOSCH**

Fault	Possible cause	Action
Detergent in chamber I is not wash away.	A programme without Prewash function was selected.	Select "Cottons/coloureds 90°C Prewash"
Water cannot be seen in drum.	This is not a fault. The water lies below the visible part of the drum.	
Motor noise	Not a malfunction! It is normal for noises to be heard while the motor is running.	
Pump noise	Not a malfunction! It is normal for noises to be heard from the pump during the start or the final stage of draining the drum.	
Vibrations when washing and spinning	Transit bolts not removed.	Follow the directions in the installation instructions (page 26)
	The machine's feet were not secured.	Realign the machine using a spirit level, see the installation instructions.
Washing solution is not completely drained. Rinse and Spin/End indicator lights flash .	Loose debris is blocking the pump.	Clean the pump. (refer to Page 20)
	Fluff-producing laundry was washed at a high temperature. The water drainage pipe or drain hose is blocked.	Clean the water drainage pipe and/or drain hose.
Water is flowing out from underneath the machine.	The thread of the supply hose is not tight.	Tighten the thread.
	Leak in the drain hose.	Replace the drain hose.
Foam coming out of the detergent dispenser.	Too much detergent.	Mix 1 tablespoon of fabric softener with 1/2 litre of water and pour into chamber I of the detergent dispenser.
		Reduce the amount of detergent next time.
Repeated spinning at short intervals.	This is not a fault. The imbalance compensation system is attempting to balance the load through repeated spins.	
The programme takes longer than usual.	This is not a fault. The imbalance compensation system is attempting to balance the load by distributing the laundry more evenly.	Wash large and small items together to reduce imbalances.
	The foam detection feature has activated an additional rinsing cycle to reduce the amount of foam.	Add a more appropriate amount of detergent next time.
Unsatisfactory washing result.	The degree of dirt was higher than supposed.	Select a more suitable programme.
	Not enough detergent.	Add detergent according to the manufacturer's specifications.



## Operating Instructions

**BOSCH**

<b>Fault</b>	<b>Possible cause</b>	<b>Action</b>
Detergent residual on the laundry.	Some phosphate-free detergents contain water-insoluble residues that may appear as light spots on the laundry.	Select Rinsing immediately, or brush off spots when laundry is dry.
Grey residues on the laundry.	Dirt accumulation from ointments, fats or oils.	Add the maximum amount of detergent and select the highest permissible temperature next time.

# Installation Instructions

**BOSCH**

## Installation, Connection and Transport Safety information

### ⚠ Risk of injury

The washing machine is heavy. Take care when lifting it.

### Caution

Frozen hoses can tear/burst. Do not install the washing machine outdoors or in an area prone to frost.

Take care not to damage the washing machine . Do not hold onto protruding parts (e.g. Loading door ) when lifting.

In addition to the safety information listed here, the local water and electricity supplier may have special requirements.

If in any doubt, have the appliance connected by an authorized technician.

Before leaving the factory every machine is thoroughly tested under operating conditions any moisture or residual water which you may find in the machine or grainage hose are left over from this testing.

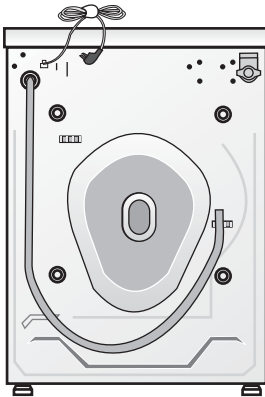

On the back of the machine:

- Water drain hose.
- Power cord.

The following tools are helpful:

- Wrench.
- Spirit level.

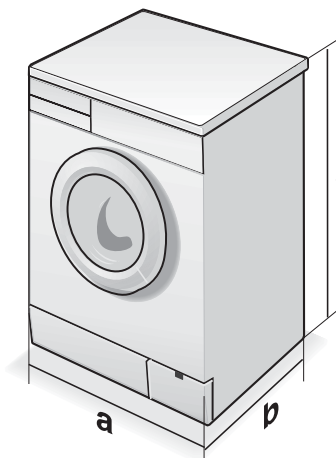

### Dimensions

- a=595mm
- b=560mm
- c=860mm
- Approx. weight=68Kg



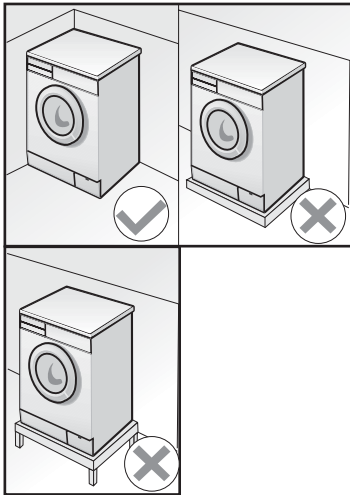

## Installation location

To ensure the proper operation of the machine, please pay attention to the following when you install the machine.

- The machine should be installed on the solid and flat floor, never put the machine on the soft carpet or on the wood floor. Do not installed the machine on the homemade plinth, if the installation location cannot be changed, the plinth must be improved as required, such as enlarge the size, secure with brackets. Never put the machines on the separate brackets. It is possible the machine moves a little by the factors of overloading, situation of the plinth(wet) and so on, so it will be a risk the machine falls down from the plinth after working for a period of time.
- Keep the environment dry and vented.
- Never put small appliance, such as microwave oven; and/or jar cooker, on the machine.
- Keep the machine away from the flaming equipment, such as candle; cooking stove;liquefied gas container etc.
- Never put the pressure containers on the machine.
- Never put the machine over the opening of an uncovered drainage.
- In the case of suspended wooden floors, place the machine on a water-resistant wooden board (plinth) of at least 30mm thickness which is screwed to the floor. If possible, install the machine in a corner of the room. Secure the machine's feet with brackets (this applies particularly to tower arrangements).

## Removing the transport bolts

The transport bolts must always be removed before using the appliance for the first time and must be retained for any subsequent transport (e.g. when moving). Use the spanner provided only if a ring spanner is unavailable.

- Undo the 4 fixing bolts A and remove them.
- Remove the four spacers B. They will fall to the floor when you tip the machine.

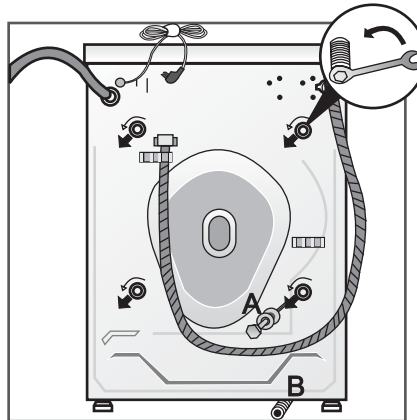

- Insert cover caps C which you will find in the bag containing the documentation.

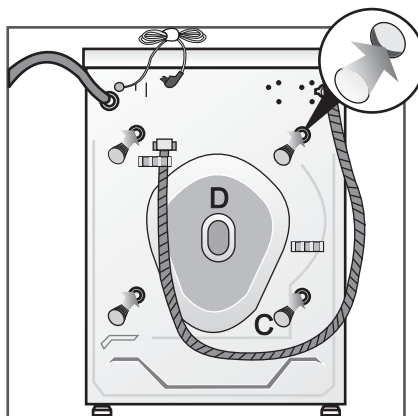

## Hose and cable lengths

Left-hand connection

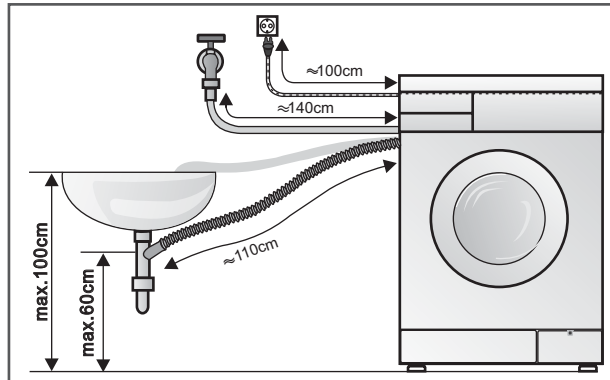

Right-hand connection

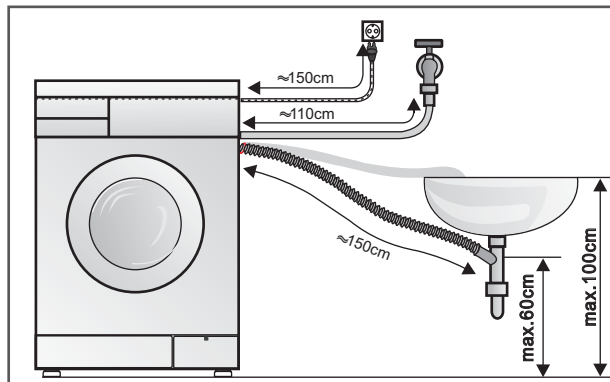

## Water connection

### Water supply

For the water connection a standard cold-water line with a minimum water pressure of 0.1MPa is required (with tap full ON, at least 8 litres of water must flow out in one minute). If the water pressure exceeds 1MPa, a pressure reducing valve must be added.

- Never connect the machine to the mixer tap of a pressure-less hot-water heater.
- **Caution!** Connections are under full water pressure, check for leaks with tap turned fully ON.
- The filters at the free end of the inlet hose and at the back of machine should only be removed for cleaning purposes.
- To avoid water damage, the tap must be turned OFF after using the machine.

## Installation Instructions

BOSCH

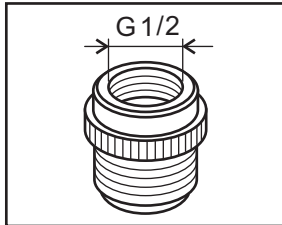

Plastic connector  
CS code 424387



Water tap  
CS code 184611

- The plastic nuts on the hose connections must only be tightened by hand.
- For tight connection between washing machine and water source, you can:

1. Call Customer Service before you install the machine, get the plastic connector freely. It may connect tightly the water inlet pipe and your water tap.

2. Or you may purchase the specific water tap from customer service. It is designed by factory. It may be better connected with machine than your water tap.

Note: The water tap is not free.

### Caution:

- Do not disassemble the water inlet hose frequently, the untight connection will lead to leakage. We suggest that you use a water inlet hose specially for the washing machine.
- If you need lengthen the water inlet hose together with the machine, please contact local ASS center/station or leader to buy additional lengthening hose.
- Additional lengthening water inlet hose is not free.



## Water Drainage

### Caution

Do not bend or pull the water drainage hose.

Height between the placement area and drainage point:  
maximum 100cm  
minimum 60cm



Drainage into a wash basin( The hose elbow is in the drum).

### Caution

The plug must not block the drain of the wash basin.

- Secure the water drainage hose so that it does not slide out.
- When water is being drained, check that the water flow is fast enough.

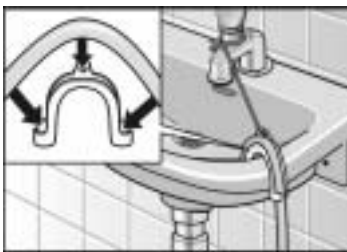

## Leveling procedure

All four appliance feet must be firmly on the ground.  
The washing machine must not wobble

Level the washing machine with the assistance of the four adjustable feet and a spirit level.

- Loosen the counter-nut 1 using the wrench.
- Adjust the height by means of turning the appliance foot 2.
- Tighten the counter-nut 1.

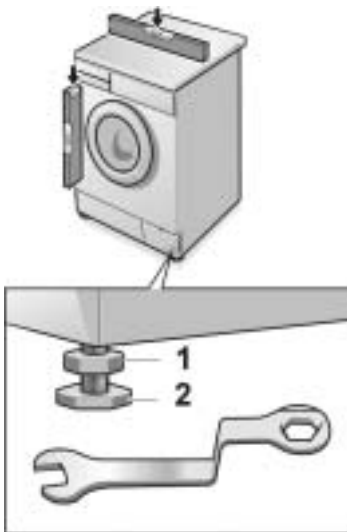

## Transport e.g. when moving

Before transporting the washing machine:

- Turn off the water tap,
- Drain any residual washing solution (refer to Page 21),
- Release the water pressure in the supply hose (refer to Page 21),
- Disconnect the washing machine from the mains,
- Dismantle the supply and drainage hose,  
Install the transport bolts.
- Having transported the appliance and ensured proper installation and connection, allow the "Spin" programme to run through before starting the first wash programme.

## Preparing and inserting the transport bolts

- Remove the covers C.
- Remove the back panel D (see Page 28), preparing the transit bolt.
- Insert and tighten the bolts.

## Electrical connection

- When heating, the maximum current of the washing machine is 10A, so please make sure that the power supply system (voltage, current and cable) is applicable to the load of the applied appliance.
- The machine must only be connect to an alternating current supply via a correctly installed earthed socket.
- The voltage indicated on the rating plate at the back of the machine must match the mains voltage at the installation location.
- Connected load and required fuse or line protecting cut-out are indicated on the rating plate.
- It must be ensured that the plug and socket match, that the conductor cross-section is sufficient and that the earthing system has been installed in compliance with regulations.
- Multiple plug connectors and extension cables must not be used.
- Do not connect the machine to electrical outlets while your hands are wet or damp.
- To remove the plug from the socket, grasp the plug firmly and pull it out. Do not pull at the cable.
- If the supply cord is damaged, it will be replaced by a special cord or a assembly available from the manufacturer or its service agent.-
- In the event that an earth-leakage circuit breaker is to be used, only use types marked with the following symbol: . Only this symbol can guarantee compliance with all current regulations.

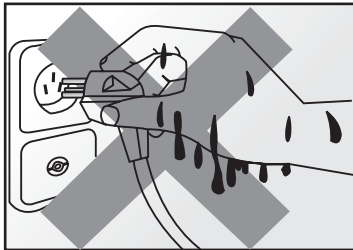

## Technical Data & Package List Sheet

34

**BOSCH**

### Technical Data

<b>Items</b> \ <b>Models</b>	WFD50810	WFD50818
Rated voltage:	220V~	220V~
Rated frequency:	50Hz	50Hz
Washing capacity:	5.2kg	5.2kg
Spinning capacity:	5.2kg	5.2kg
Water pressure:	0.1~1MPa	0.1~1MPa
Water proof:	IPX4	IPX4
Washing power:	200W	200W
Spinning power:	460W	460W
Heating power:	1800W	1800W
Maximum power:	2000W	2000W
Maximum current:	10A	10A

### Package List Sheet

<b>Items</b> \ <b>Models</b>	WFD50810	WFD50818
Washing machine	1	1
User manual	1	1
Fastening plug	4	4
Inlet hose	1	1
Bottom cover	1	1

### Maintenance instruction

- According to the Regulations of Responsibility concerning Repair, Exchange and Return of some commodities, warranty period of appliance purchased for home use purpose is one year for the complete unit and three years for the functional parts. Warranty period of appliances purchased for business, commercial or company use is 3 months for complete unit and functional parts unless otherwise specified in the contract.
- Warranty period for appliance sold at reduced prices is same, but no warranty claim for price reduced position.
- Within warranty period, the consumer should show the valid purchase invoice of the appliance and other relevant guarantee documents defined by the manufacturer when asking for free of charge repair. Consumer should keep the warranty card and the purchase invoice properly and show them together when asking for free of charge repair. The warranty period starts from the invoice date. If the customer loses the invoice, it starts from the manufacturing date.
- The following cases are not covered by the free of charge repair and should be paid by the customer:
  - Damage caused by improper transportation, installation, operation, maintenance and storage by customer.
  - Damage caused by power supply on customer site less than 187V or more than 240V.
  - Damage caused by unauthorized repair.
  - Without valid purchase invoice or without relevant guarantee document.
  - The guarantee document is amended by customer or does not accord with the appliance.
  - Damage caused by force majeure.
  - Out of warranty.

If the appliances are used under condition of improper power supply, water supply, temperature or humidity, the damage and loss are not covered by the free of charge repair and should be paid by the customer.

Because the factors mentioned above is beyond the control of manufacturer.

Door label.



In order to provide prompt service, our service staff needs specific information about the appliance.

Please inform the following us in details:

- Exact address and telephone number.
- Failure description.
- Date of purchase.
- Product number (E-Nr.) and Production date(FD).  
This Nr. can be found on the door label.

## Customer Service

36

**BOSCH**

### **Service Assurance**

- 24 hours hotline service
- Door to door service within 24 hours within city boundary
- Free of charge installation except additional material cost
- Free of charge consulting
- Be responsible for service a lifetime long







# Customer Service

**BOSCH**

## Warranty card

<b>BOSCH</b>	Customer Name		Contact telephone	
	Address			
	Purchase date			
	Product code		Invoice no.	
	Maintenance station		Station telephone	

Record sheet 5					
<b>BOSCH</b>		Customer Name		Address	
		Purchase date		Invoice no.	
		Product code		Production date	
		Maintenance date		Serial number	
Record sheet 4					
<b>BOSCH</b>		Customer Name		Address	
		Purchase date		Invoice no.	
		Product code		Production date	
		Maintenance date		Serial number	
Record sheet 3					
<b>BOSCH</b>		Customer Name		Address	
		Purchase date		Invoice no.	
		Product code		Production date	
		Maintenance date		Serial number	
Record sheet 2					
<b>BOSCH</b>		Customer Name		Address	
		Purchase date		Invoice no.	
		Product code		Production date	
		Maintenance date		Serial number	
Record sheet 1					
<b>BOSCH</b>		Customer Name		Address	
		Purchase date		Invoice no.	
		Product code		Production date	
		Maintenance date		Serial number	

9000086867 (PD 85 12 10)

WFD50810

WFD50818

800免费咨询电话：8008280088

全国统一客户服务专线：4008855888

未开通800地区拨打：0550-3062800 传真：0550-3072600

客户服务电子信箱E-mail: [Careline.China@BSHG.com](mailto:Careline.China@BSHG.com)

**BOSCH**